

Data sheet | Item number: 2206-1301

3-conductor through terminal block; with push-button; 6 mm²; with test port; suitable for Ex e II applications; side and center marking; for DIN-rail 35 x 15 and 35 x 7.5; Push-in CAGE CLAMP®; 6,00 mm²; gray

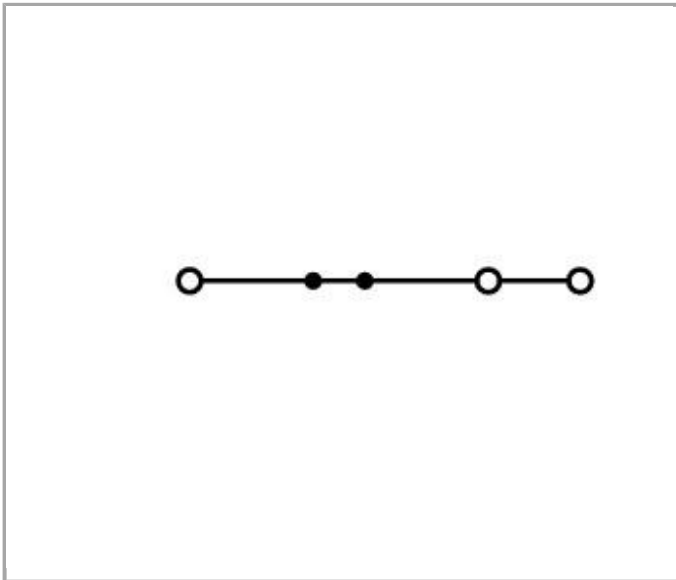

2206-1301

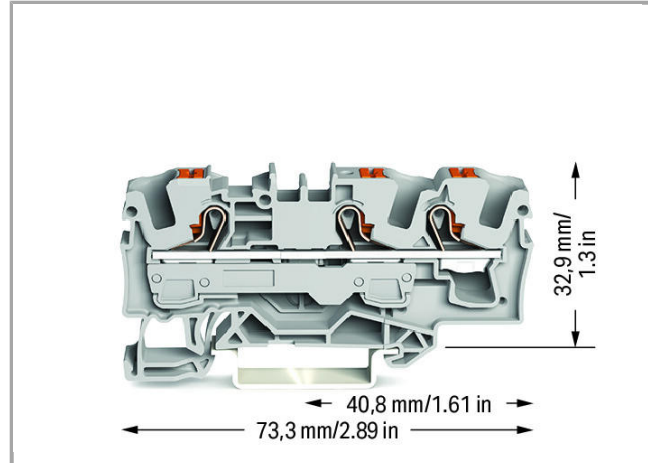
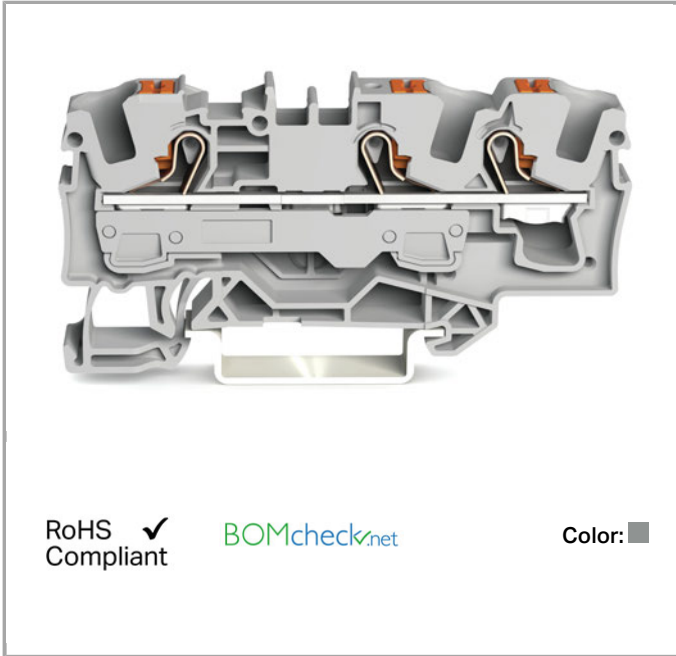

Data

Electrical data

Ratings per IEC/EN 60664-1

Rated voltage (III / 3)	800 V
Rated impulse voltage (III / 3)	8 kV



Rated current	41 A
Rated current (2)	57 A

Approvals per UL 1059

Rated voltage UL (Use Group B)	600 V
Rated current UL (Use Group B)	50 A
Rated voltage UL (Use Group C)	600 V
Rated current UL (Use Group C)	50 A

Connection data

Connection technology	Push-in CAGE CLAMP®
Actuation type	Push-in Push-button
Connectable conductor materials	Copper
Nominal cross section	6 mm ²
Solid conductor	0.5 10 mm ² / 20 8 AWG
Solid conductor, push-in termination	1 10 mm ² / 14 8 AWG
Fine-stranded conductor	0.5 10 mm ² / 20 8 AWG
Strip length	13 15 mm / 0.51 0.59 inch
Note (conductor cross-section)	Depending on the conductor characteristic, a conductor with a smaller cross section can also be inserted via push-in termination.
Total number of connection points	3
Total number of potentials	1
Number of levels	1
Type of wiring	Front-entry wiring
Number of jumper slots	2

Geometrical Data

Width	7.5 mm / 0.295 inch
Height from upper-edge of DIN-35 rail	32.9 mm / 1.295 inch
Depth	73.3 mm / 2.886 inch

Mechanical data

Design	horizontal
Type of mounting	DIN-35 rail
Marking level	Center/side marking

Material Data

Color	gray
Insulating material	Polyamide 66 (PA 66)

Fire load	0.215 MJ
Weight	12.934 g

Commercial data

Country of origin	DE
GTIN	4055143712088
Customs Tariff No.	85369010000

Approvals / Certificates

Ex-Approvals

Logo	Approval	Additional Approval Text	Certificate name
	AEx Underwriters Laboratories Inc.	UL 60079	4788362294
	AEx Underwriters Laboratories Inc.	UL 60079	4788362294
	ATEX Physikalisch Technische Bundesanstalt	IEC 60079-0	PTB 18 ATEX 1007 U
	ATEX Physikalisch Technische Bundesanstalt	IEC 60079-0	PTB 18 ATEX 1007 U
	IECEX Physikalisch Technische Bundesanstalt	IEC 60079	IECEX PTB 18.0014U (Ex eb IIC Gb and Ex eb I Mb)
	IECEX Physikalisch Technische Bundesanstalt	IEC 60079	IECEX PTB 18.0014U (Ex eb IIC Gb and Ex eb I Mb)

Radio-Approvals

Logo	Approval	Additional Approval Text	Certificate name
	CCA DEKRA Certification B.V.	EN 60947	NTR NL 7667
	CSA	C22.2	70175034





DEKRA Certification B.V.

KEMA/KEUR
DEKRA Certification B.V.



EN 60947

71-
102879

Country specific Approvals

Logo	Approval	Additional Approval Text	Certificate name
	CCA DEKRA Certification B.V.	EN 60947	NTR NL 7667
	CSA DEKRA Certification B.V.	C22.2	70175034
	KEMA/KEUR DEKRA Certification B.V.	EN 60947	71- 102879

Ship Approvals

Logo	Approval	Additional Approval Text	Certificate name
	ABS American Bureau of Shipping	-	19- HG1866350- PDA
	DNV GL Det Norske Veritas, Germanischer Lloyd	-	TAE00003JT
	LR Lloyds Register	-	19/20050

Other Approvals





Logo	Approval	Additional Approval Text	Certificate name
	UL Underwriters Laboratories Inc.	C22.2 No. 158	478863229

UL-Approvals

Logo	Approval	Additional Approval Text	Certificate name
	UL Underwriters Laboratories Inc.	C22.2 No. 158	478863229

Compatible products





End plate



















	Item no.: 2006-1391 End and intermediate plate; 1 mm thick; gray	2006-1391
	Item no.: 2006-1392 End and intermediate plate; 1 mm thick; orange	2006-1392
	Item no.: 2006-1393 Separator plate; 2 mm thick; oversized; gray	2006-1393
	Item no.: 2006-1394 Separator plate; 2 mm thick; oversized; orange	2006-1394

















General accessories

















	Item no.: 2006-191 Lockout cap; for wire insertion and actuating opening; gray	2006-191
--	---	----------















Jumper











	Item no.: 2006-402 Push-in type jumper bar; insulated; 2-way; Nominal current 41 A; light gray	2006-402
	Item no.: 2006-403 Push-in type jumper bar; insulated; 3-way; Nominal current 41 A; light gray	2006-403
	Item no.: 2006-404 Push-in type jumper bar; insulated; 4-way; Nominal current 41 A; light gray	2006-404
	Item no.: 2006-405 Push-in type jumper bar; insulated; 5-way; Nominal current 41 A; light gray	2006-405
	Item no.: 2006-405/011-000 Star point jumper; insulated; 3-way (1-3-5); IN = IN terminal block; light gray	2006-405 /011-000

	Item no.: 2006-433 Push-in type jumper bar; insulated; from 1 to 3; Nominal current 41 A; light gray	2006-433
	Item no.: 2006-434 Push-in type jumper bar; insulated; from 1 to 4; Nominal current 41 A; light gray	2006-434
	Item no.: 2006-435 Push-in type jumper bar; insulated; from 1 to 5; Nominal current 41 A; light gray	2006-435
	Item no.: 2006-499 Step-down jumper; insulated; from 6/4 mm ² to 4/2.5/1.5 mm ² ; Nominal current 32 A; light gray	2006-499
	Item no.: 2016-499 Step-down jumper; insulated; from 16/10 mm ² to 10/6/4/2.5 mm ² ; Nominal current 57 A; light gray	2016-499
	Item no.: 210-103 Wire commoning chain; insulated; 50 connections; black	210-103
	Item no.: 210-123 Wire commoning chain; insulated; 50 connections	210-123
Carrier rail		
	Item no.: 210-112 Steel carrier rail; 35 x 7.5 mm; 1 mm thick; 2 m long; slotted; according to EN 60715; "Hole width 25 mm	210-112
	Item no.: 210-113 Steel carrier rail; 35 x 7.5 mm; 1 mm thick; 2 m long; unslotted; according to EN 60715	210-113
	Item no.: 210-114 Steel carrier rail; 35 x 15 mm; 1.5 mm thick; 2 m long; unslotted; similar to EN 60715	210-114
	Item no.: 210-115 Steel carrier rail; 35 x 7.5 mm; 1 mm thick; 2 m long; slotted; according to EN 60715; "Hole width 18 mm	210-115
	Item no.: 210-118 Steel carrier rail; 35 x 15 mm; 2.3 mm thick; 2 m long; unslotted; according to EN 60715	210-118
	Item no.: 210-196 Aluminum carrier rail; 35 x 8.2 mm; 1.6 mm thick; 2 m long; unslotted; similar to EN 60715; silver-colored	210-196
	Item no.: 210-197 Steel carrier rail; 35 x 15 mm; 1.5 mm thick; 2 m long; slotted; similar to EN 60715	210-197
	Item no.: 210-198 Copper carrier rail; 35 x 15 mm; 2.3 mm thick; 2 m long; unslotted; according to EN 60715; copper-colored	210-198
check		
	Item no.: 2006-511 Modular TOPJOB®S connector; modular; for jumper contact slot; 1-pole; 6,00 mm ² ; gray	2006-511
	Item no.: 2006-549 Spacer module; modular; e.g., for bridging commoned terminal blocks; gray	2006-549
	Item no.: 2009-174 Test plug adapter; for 4 mm Ø test plugs; for testing TOPJOB®S rail-mounted terminal blocks; gray	2009-174

	Item no.: 2009-182 Testing tap; for max. 2.5 mm ² ; tool-free connection for individual test wires 0.08 - 2.5 mm; gray	2009-182
	Item no.: 210-136 Test plug; 2 mm Ø; with 500 mm cable; red	210-136
ferrule		
	Item no.: 216-208 Ferrule; Sleeve for 6 mm ² / AWG 10; insulated; electro-tin plated; electrolytic copper; gastight crimped; acc. to DIN 46228, Part 4/09.90; yellow	216-208
	Item no.: 216-262 Ferrule; Sleeve for 0.75 mm ² / 18 AWG; insulated; electro-tin plated; electrolytic copper; gastight crimped; acc. to DIN 46228, Part 4/09.90; gray	216-262
	Item no.: 216-263 Ferrule; Sleeve for 1 mm ² / AWG 18; insulated; electro-tin plated; electrolytic copper; gastight crimped; acc. to DIN 46228, Part 4/09.90; red	216-263
	Item no.: 216-264 Ferrule; Sleeve for 1.5 mm ² / AWG 16; insulated; electro-tin plated; electrolytic copper; gastight crimped; acc. to DIN 46228, Part 4/09.90; black	216-264
	Item no.: 216-266 Ferrule; Sleeve for 2.5 mm ² / AWG 14; insulated; electro-tin plated; electrolytic copper; gastight crimped; acc. to DIN 46228, Part 4/09.90; blue	216-266
	Item no.: 216-267 Ferrule; Sleeve for 4 mm ² / AWG 12; insulated; electro-tin plated; electrolytic copper; gastight crimped; acc. to DIN 46228, Part 4/09.90; gray	216-267
tools		
	Item no.: 210-721 Operating tool; Blade: 5.5 x 0.8 mm; with a partially insulated shaft	210-721
Marking accessories		
	Item no.: 2009-110 Marking strips; on reel; not stretchable; plain; snap-on type; white	2009-110
	Item no.: 2009-115 WMB-Inline; for Smart Printer; on reel; stretchable 5 - 5.2 mm; plain; snap-on type; white	2009-115
	Item no.: 2009-115/000-002 WMB-Inline; for Smart Printer; on reel; stretchable 5 - 5.2 mm; plain; snap-on type; yellow	2009-115 /000-002
	Item no.: 2009-115/000-006 WMB-Inline; for Smart Printer; on reel; stretchable 5 - 5.2 mm; plain; snap-on type; blue	2009-115 /000-006
	Item no.: 2009-115/000-007 WMB-Inline; for Smart Printer; on reel; stretchable 5 - 5.2 mm; plain; snap-on type; gray	2009-115 /000-007
	Item no.: 2009-115/000-012 WMB-Inline; for Smart Printer; on reel; stretchable 5 - 5.2 mm; plain; snap-on type; orange	2009-115 /000-012
	Item no.: 2009-115/000-017 WMB-Inline; for Smart Printer; on reel; stretchable 5 - 5.2 mm; plain; snap-on type; light green	2009-115 /000-017

	Item no.: 2009-115/000-023 WMB-Inline; for Smart Printer; on reel; stretchable 5 - 5.2 mm; plain; snap-on type; green	/000-023	2009-115
	Item no.: 2009-115/000-024 WMB-Inline; for Smart Printer; on reel; stretchable 5 - 5.2 mm; plain; snap-on type; violet	/000-024	2009-115
	Item no.: 2009-145 Mini-WSB Inline; for Smart Printer; on reel; stretchable 5 - 5.2 mm; plain; snap-on type; white		2009-145
	Item no.: 2009-145/000-002 Mini-WSB Inline; for Smart Printer; on reel; stretchable 5 - 5.2 mm; plain; snap-on type; yellow	/000-002	2009-145
	Item no.: 2009-145/000-005 Mini-WSB Inline; for Smart Printer; on reel; stretchable 5 - 5.2 mm; plain; snap-on type; red	/000-005	2009-145
	Item no.: 2009-145/000-006 Mini-WSB Inline; for Smart Printer; on reel; stretchable 5 - 5.2 mm; plain; snap-on type; blue	/000-006	2009-145
	Item no.: 2009-145/000-007 Mini-WSB Inline; for Smart Printer; on reel; stretchable 5 - 5.2 mm; plain; snap-on type; gray	/000-007	2009-145
	Item no.: 2009-145/000-012 Mini-WSB Inline; for Smart Printer; on reel; stretchable 5 - 5.2 mm; plain; snap-on type; orange	/000-012	2009-145
	Item no.: 2009-145/000-023 Mini-WSB Inline; for Smart Printer; on reel; stretchable 5 - 5.2 mm; plain; snap-on type; green	/000-023	2009-145
	Item no.: 2009-145/000-024 Mini-WSB Inline; for Smart Printer; on reel; stretchable 5 - 5.2 mm; plain; snap-on type; violet	/000-024	2009-145
	Item no.: 2009-191 Group marker carrier		2009-191
	Item no.: 2009-192 Group marker carrier		2009-192
	Item no.: 2009-193 Group marker carrier		2009-193
	Item no.: 2009-198 Adaptor		2009-198
	Item no.: 248-501 Miniature WSB Quick marking system; plain; Marker width 5 mm; 10 strips with 10 markers per card		248-501
	Item no.: 248-501/000-002 Mini-WSB marking card; as card; not stretchable; plain; snap-on type; yellow	/000-002	248-501

	Item no.: 248-501/000-005 Mini-WSB marking card; as card; not stretchable; plain; snap-on type; white	248-501 /000-005
	Item no.: 248-501/000-006 Mini-WSB marking card; as card; not stretchable; plain; snap-on type; white	248-501 /000-006
	Item no.: 248-501/000-007 Mini-WSB marking card; as card; not stretchable; plain; snap-on type; white	248-501 /000-007
	Item no.: 248-501/000-012 Mini-WSB marking card; as card; not stretchable; plain; snap-on type; white	248-501 /000-012
	Item no.: 248-501/000-017 Mini-WSB marking card; as card; not stretchable; plain; snap-on type; white	248-501 /000-017
	Item no.: 248-501/000-023 Mini-WSB marking card; as card; not stretchable; plain; snap-on type; white	248-501 /000-023
	Item no.: 248-501/000-024 Mini-WSB marking card; as card; not stretchable; plain; snap-on type; white	248-501 /000-024
	Item no.: 793-501 WMB marking card; as card; not stretchable; plain; snap-on type; white	793-501
	Item no.: 793-501/000-002 WMB marking card; as card; not stretchable; plain; snap-on type; white	793-501 /000-002
	Item no.: 793-501/000-005 WMB marking card; as card; not stretchable; plain; snap-on type; white	793-501 /000-005
	Item no.: 793-501/000-006 WMB marking card; as card; not stretchable; plain; snap-on type; white	793-501 /000-006
	Item no.: 793-501/000-007 WMB marking card; as card; not stretchable; plain; snap-on type; white	793-501 /000-007
	Item no.: 793-501/000-012 WMB marking card; as card; not stretchable; plain; snap-on type; white	793-501 /000-012
	Item no.: 793-501/000-017 WMB marking card; as card; not stretchable; plain; snap-on type; white	793-501 /000-017
	Item no.: 793-501/000-023 WMB marking card; as card; not stretchable; plain; snap-on type; white	793-501 /000-023

	Item no.: 793-501/000-024 WMB marking card; as card; not stretchable; plain; snap-on type; white	793-501 /000-024
	Item no.: 793-5501 WMB marking card; as card; for terminal block width 5 - 17.5 mm; stretchable 5 - 5.2 mm; plain; snap-on type; white	793-5501
	Item no.: 793-5501/000-002 WMB marking card; as card; for terminal block width 5 - 17.5 mm; stretchable 5 - 5.2 mm; plain; snap-on type; yellow	793-5501 /000-002
	Item no.: 793-5501/000-005 WMB marking card; as card; stretchable 5 - 5.2 mm; plain; snap-on type; red	793-5501 /000-005
	Item no.: 793-5501/000-006 WMB marking card; as card; stretchable 5 - 5.2 mm; plain; snap-on type; blue	793-5501 /000-006
	Item no.: 793-5501/000-007 WMB marking card; as card; stretchable 5 - 5.2 mm; plain; snap-on type; gray	793-5501 /000-007
	Item no.: 793-5501/000-012 WMB marking card; as card; stretchable 5 - 5.2 mm; plain; snap-on type; orange	793-5501 /000-012
	Item no.: 793-5501/000-017 WMB marking card; as card; stretchable 5 - 5.2 mm; plain; snap-on type; light green	793-5501 /000-017
	Item no.: 793-5501/000-023 WMB marking card; as card; stretchable 5 - 5.2 mm; plain; snap-on type; green	793-5501 /000-023
	Item no.: 793-5501/000-024 WMB marking card; as card; stretchable 5 - 5.2 mm; plain; snap-on type; violet	793-5501 /000-024

Downloads

Documentation

Bid Text

2206-1301	docx 15.2 kB	Download
-----------	-----------------	----------

Additional Information

Technical explanations	Apr 3, 2019	pdf 2.1 MB	Download
------------------------	-------------	---------------	----------

CAD/CAE - Smart Data

CAD data



3D Download 2206-1301

[Download](#)

EPLAN

EPLAN Data Portal

[Download](#)

Subject to changes.
